

## Modular Pressure Relief Valve

Model: ZDB/Z2DB16(22)...-3XJ



- ◆ Size 16 and 22
- ◆ Maximum working pressure 315 bar
- ◆ Maximum working flow 200 L/min  
400 L/min

### Contents

Function description, sectional drawing	02
Models and specifications	02
Functional symbols	03
Technical parameters	03
Characteristic curve	04
Component size	05-08

### Features

- Sandwich plate type
  - The installation surface according to DIN2430A and ISO4401
  - Threaded connection and subplate mounting
  - 4 pressure ratings
  - 5 circuit options
  - With one or two cartridge relief valves
  - 1 adjustment element
- Adjusting screw with protective cap

Any part of this brochure can not be reproduced, edited, copied and disseminated electronically in any way without authorization of Jiayite Hydraulics company. As the product is in constant development and innovation, the information in this brochure is not specific to the special conditions or applicability of a specific industry, thus Jiayite Hydraulics company is not responsible for any incomplete or inaccurate description generated.



**Function description, sectional drawing**

Relief valve model ZDB and Z2DB are pilot operated relief valve and of sandwich plate design. It's used to limit the pressure within hydraulic system. The valve is composed of valve body (7), with one or two cartridge relief valves, The system pressure is set by adjustment element (4). At rest, the valve is closed. Pressure in port A acts on valve spool (1), at the same time pressure pass through orifice (2) acts on spring, and pass through orifice (3) acts on pilot valve spool (6), if pressure of port A rises above the value set on spring (5), then the pilot valve spool (6) opens. Hydraulic oil flow spring loaded side of the valve spool (1) and orifice (3) into port T. The pressure drop moves valve spool (1) thereby opening the connection A to T, while maintaining the pressure set at spring (5). Pilot oil return from two spring chambers via port T externally.

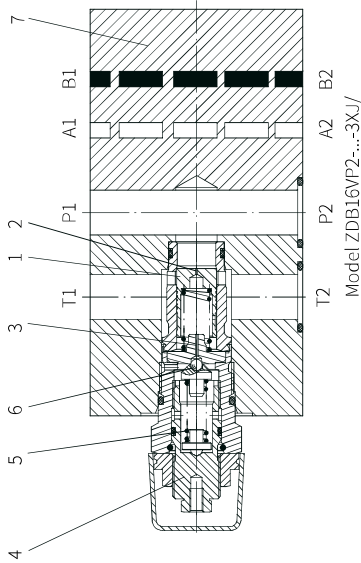

**Functional symbols**

①= Valve side ②= Subplate side

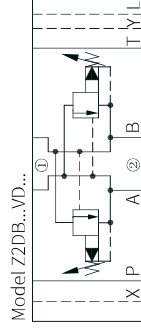
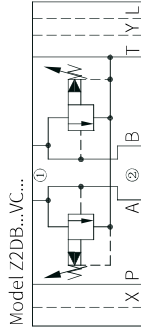
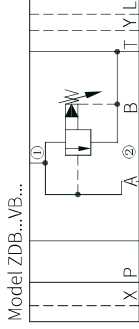
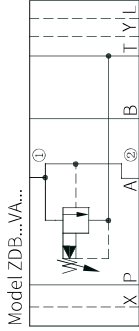

**Technical parameters**

Oil fluid	Mineral oil - for NBR seal and FKM seal Phosphate oil - for FKM seal
Working medium temperature range	-30 to +80 (NBR seals) -20 to +80 (FKM seals)
Viscosity range	10 to 800 mm <sup>2</sup> /s
Cleanliness of oil	The maximum allowable pollution level of oil is ISO4406 Class 20/18/15
Maximum working pressure	bar to 315
Maximum setting pressure	bar 50, 100, 200, 315
Size	16 22
Maximum flow	L/min 200 400
Weight	ZDB about 9.4 kg
	Z2DB about 11.8 kg

**Models and specifications**

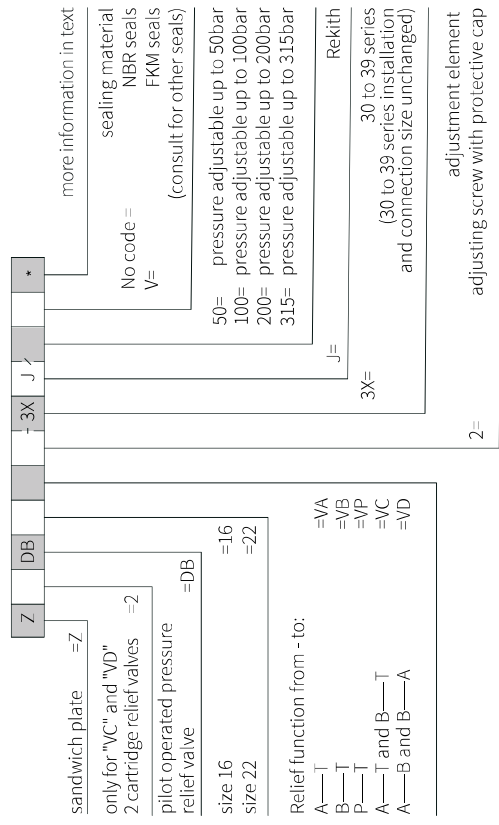

### Characteristic curve

(Measured when using HLP 46,  $\rho_{oil} = 40^\circ\text{C} \pm 5^\circ\text{C}$ )

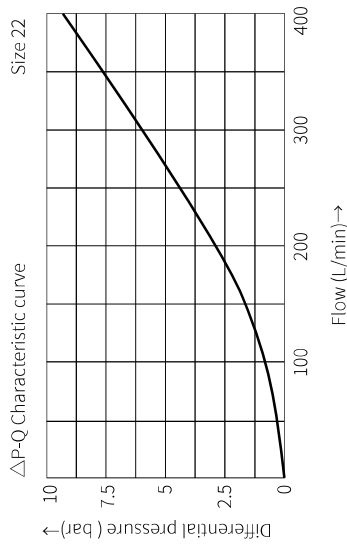
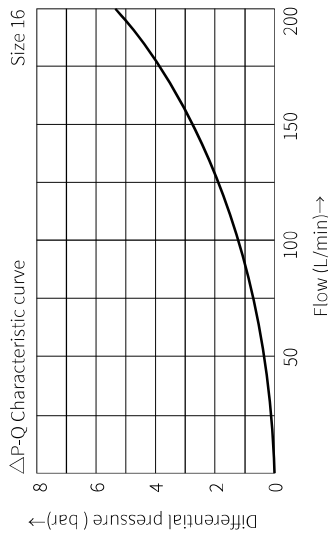

### Component size

Model ZDB16VA...-3XJ/... and ZDB16VP...-3XJ/...

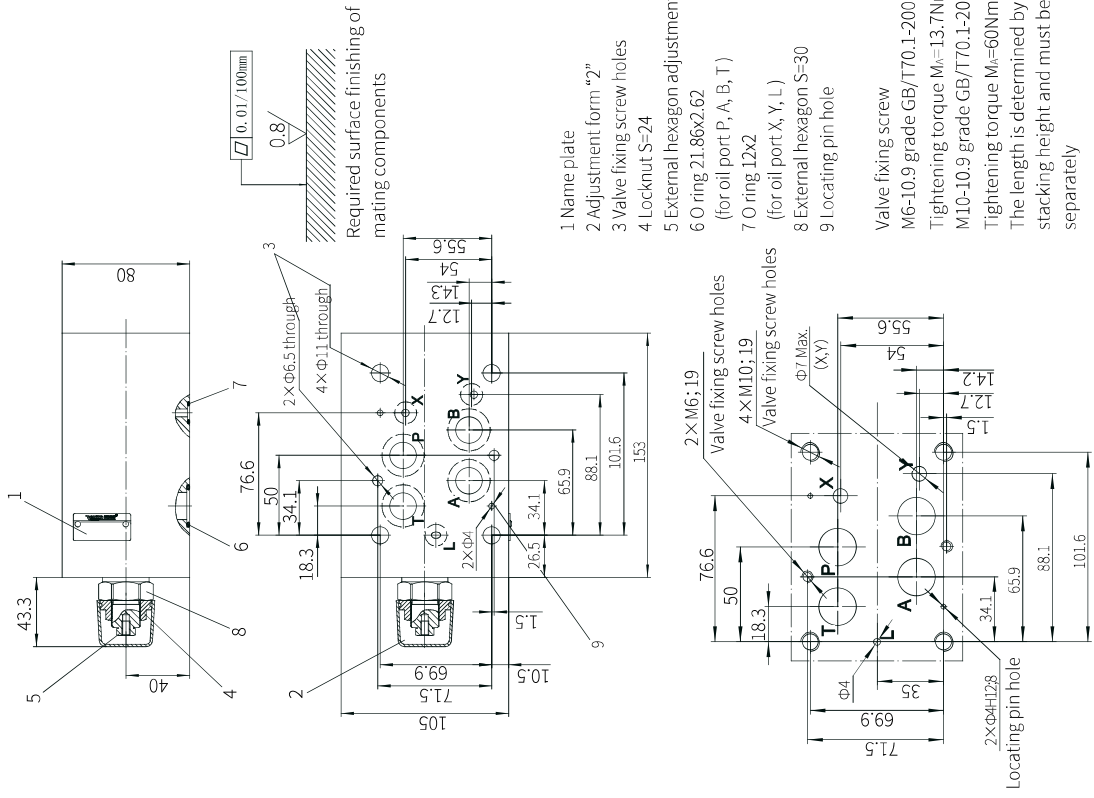

Component size

Size unit: mm

Model Z2DB16VD...3XJ/...

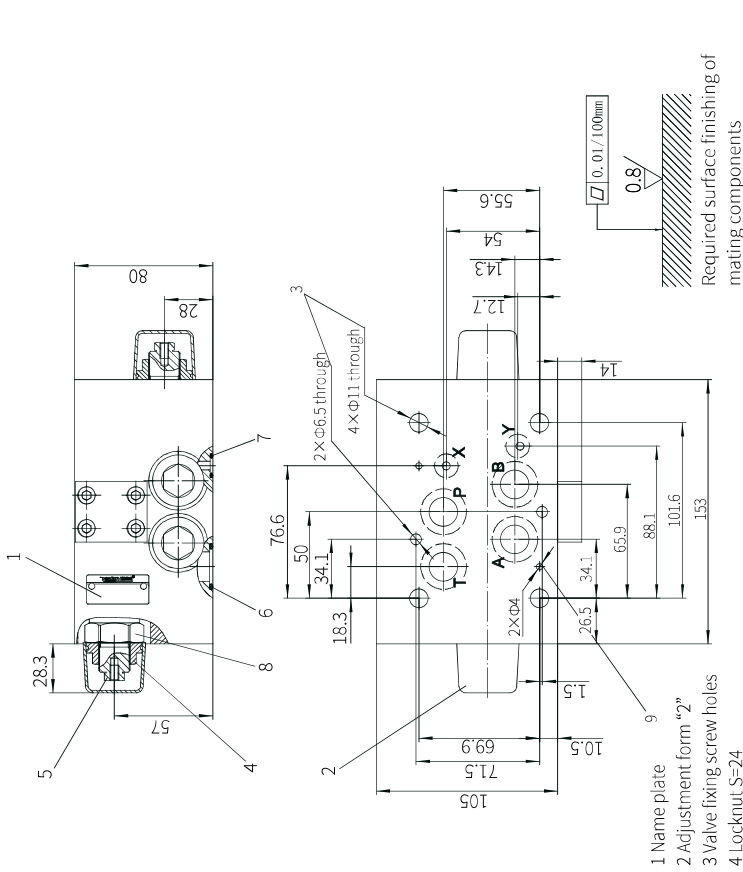

- 1 Name plate
- 2 Adjustment form "2"
- 3 Valve fixing screw holes
- 4 Locknut S=24
- 5 External hexagon adjustment screw S=10
- 6 O ring 21.86x2.62
- 7 O ring 12x2
- 8 External hexagon S=30
- 9 Locating pin hole

Valve fixing screw  
M6-10.9 grade GB/T70.1-2000  
Tightening torque  $M_t=13.7\text{Nm}$   
M10-10.9 grade GB/T70.1-2000  
Tightening torque  $M_t=60\text{Nm}$   
The length is determined by the stacking height and must be ordered separately

Component size

Size unit: mm

Model ZDB22VP...3XJ/...

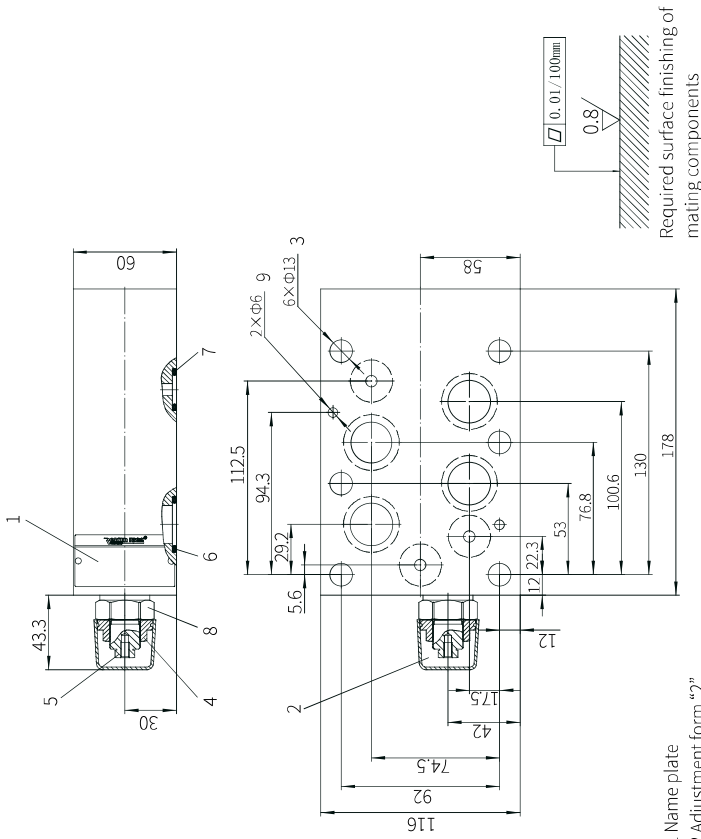

- 1 Name plate
- 2 Adjustment form "2"
- 3 Valve fixing screw holes
- 4 Locknut S=24
- 5 External hexagon adjustment screw S=10
- 6 O ring 27x3
- 7 O ring 19x3
- 8 External hexagon S=30
- 9 Locating pin hole

Valve fixing screw  
M12-10.9 grade GB/T70.1-2000  
Tightening torque  $M_t=60\text{Nm}$   
The length is determined by the stacking height and must be ordered separately

**Component size**

**Size unit: mm**

Model Z2DB22VD...-3XJ/...

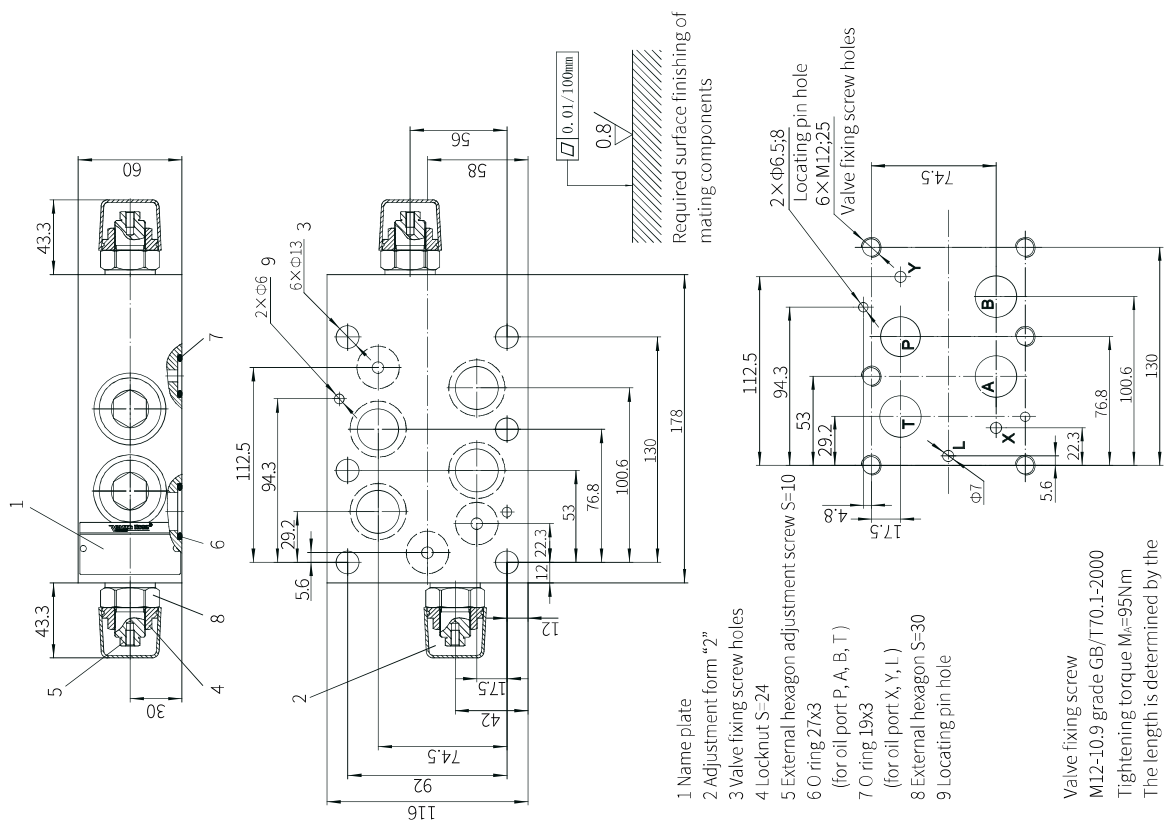

**Balanced Valve**  
Model DC...-1XJ



- ◆ Size 10 to 30
- ◆ Maximum working pressure 315 bar
- ◆ Maximum working flow 330 L/min

**Contents**

Function description, sectional drawing 02  
 Models and specifications 02  
 Functional symbols 03  
 Characteristic curve 03-04  
 Component size 05-06

**Features**

- Subplate mounting
- Threaded connection
- 3 adjustment elements
  - Rotary knob
  - Inner hexagon screw with protective cap
  - Lockable rotary knob
- 5 pressure ratings